

CENTER MOTOR 50970

SPECIFICATIONS

Position	Center
Reverse pedaling	Free
Rated Voltage	36 V
Rated Power	250 W/500 W (US/CAN)
Max. support bike speed	25-32 km/h
Max Torque	100 Nm
Efficiency	Min. 85 %
Walk assist function	No
Pedal Sensor	Speed
Pedal arms	175 mm included
Color	Black/silver
Weight	4,7 kg incl. controller
Operation Temperature	Max. 120°
Wire	IP66 Plug
Max RPM	90 RPM

FUNCTION

Gear sensor Function	Yes
Light Output (DCV / W)	36V / 10 W
Brake cut-off	Yes
Compatible Brake Type	V-brake, Roller brake, Disc brake

FURTHER SPECIFICATIONS

Drive	Sprocket
Sprocket size	38-46 teeth or hub for BCD 104 mm sprocket.
Display protocol	V1
Compatible Wheel Size	20"-29"

MOUNTING PARAMETERS

Bracket type	PM-01
--------------	-------

CABLES & CONNECTOR

- Multi Connector for Wire harness
- Battery connection
- Wheel speed sensor

TESTS & CERTIFICATIONS

- IP classification **IP54**
- Certifications **CE / EN 15194 / ROHS**

DIMENSIONS

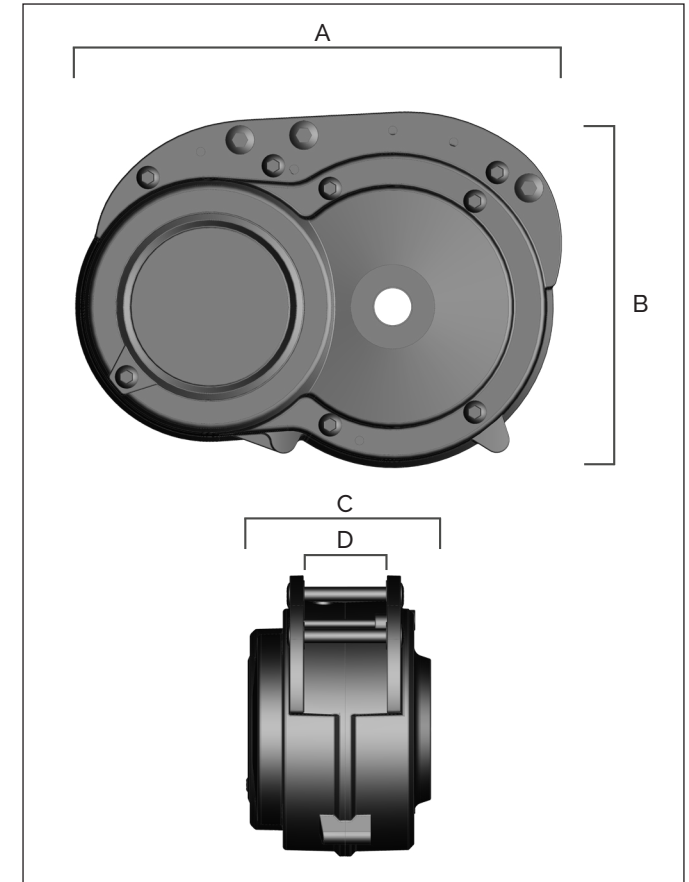

A	207,8 mm	C	98,9 mm
B	151,8 mm	D	45 mm

Promovec A/S
Brunbjergvej 2
DK-8240 Risskov

TEL. +45 7027 2623
FAX. +45 7027 2429
MAIL info@promovec.dk

Promovec® 
sustainable e-bikes